

SINCE 2010
WELLE TRADE
SOURCING & SUPPLY CHAIN SPECIALIST



About Our Family Enterprise

1994

From a 5-acre facility, we pioneered chemical production and distribution, specializing in industrial-compound formulations. This groundwork established our core expertise in scalable manufacturing and agile logistics, anchoring long-term technical leadership.

2002

Expanding to a 20-acre plant, we engineered PE/EVA/TPE vulcanized foams through dedicated production lines. Beyond high-performance sheets, we vertically integrated capabilities to deliver finished foam products, driving innovation in material science applications.

2010

Transitioning into global trade, we broadened services beyond exports. Our sourcing network now curates verified Chinese suppliers and end-to-end procurement solutions—spanning raw materials to finished goods—to empower clients' cost-efficiency and supply chain resilience.



CATALOG

Update date: April 15th, 2025



Introduction

Founded in 1994 as a family-owned enterprise, we began as specialists in chemical manufacturing before pioneering advanced polymer foaming technologies (PE/EVA/TPE vulcanized foams). Today, we have expanded into a diversified international trading business across multiple non-food industries.

With decades of hands-on production experience, we possess an unparalleled ability to identify, analyze, master, and innovate solutions for even the most complex manufacturing challenges. Our deep-rooted knowledge ensures quality and efficiency at every stage.

Our extensive supplier relationships—built on trust and rigorous vetting—enable us to swiftly source cost-effective, high-quality partners tailored to your needs. Whether for niche materials or large-scale production, we bridge the gap between demand and supply.

We redefine convenience through one-stop procurement solutions. From product selection to final delivery, we handle every detail—allowing clients to "place orders with confidence, and leave the rest to us." Our commitment: seamless transactions, zero post-order hassles.

Introduction	3
PE/TPE/EVA Foam	5
Yoga/Fitness Mat	6
Aluminium Carabiners	7
Carabiners Accessories	8
Disposable Glove	9
PE/EVA Foam Insert Tray	10
VOOF PU Sheet	11
VOOF PU Application	12
Foam/Massage Roller	13
Yoga/Foam Block	14
Aluminium Alloy Truss	15
Aluminium Accessories	16

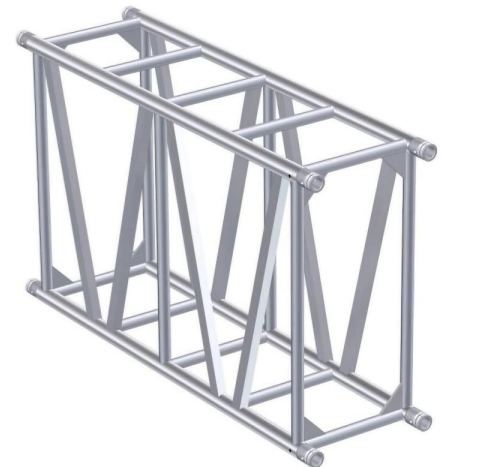
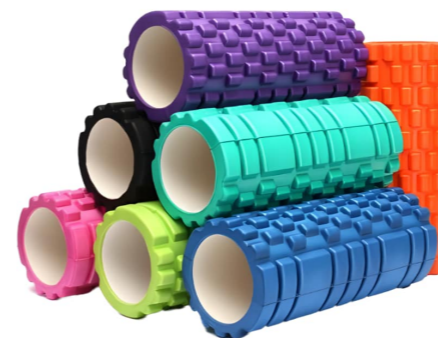
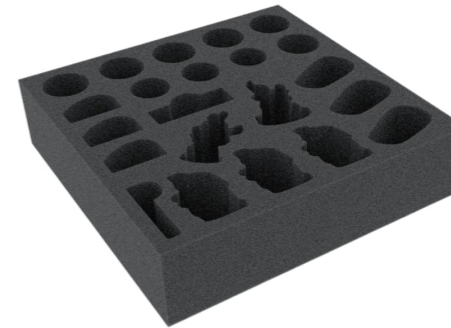

PE/TPE/EVA Foam



Pink high-expansion EVA foam sheet



White high-expansion PE foam sheet



Blue high-expansion PE foam sheet



Various types of surface layer materials



Natural rubber mat with PU surface layer



Natural rubber mat with suede fabric surface layer



PE foam sheets in different colors

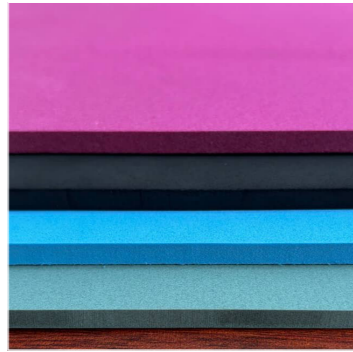

EVA foam sheets in different colors

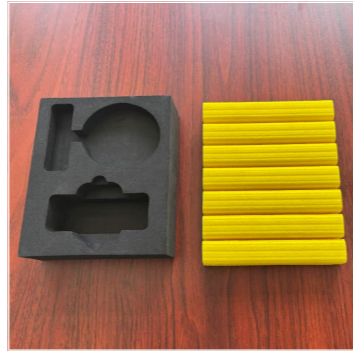

Customizable in various shapes and colors



TPE yoga mat

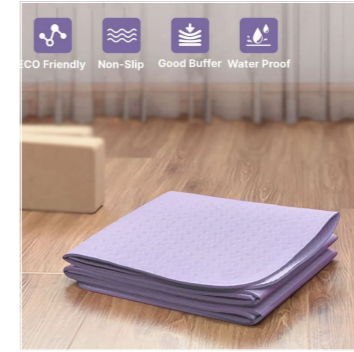

Foldable TPE yoga mat

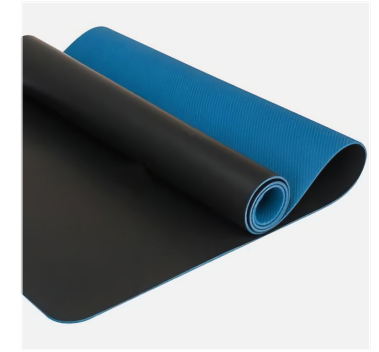

TPE yoga mat with PU surface layer

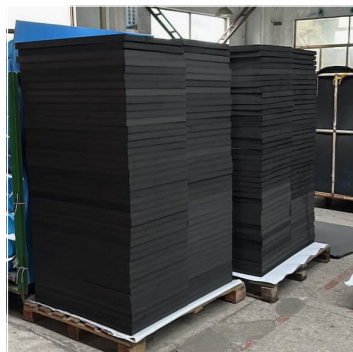

Black high-elasticity EVA foam material



Black high-expansion PE foam sheet

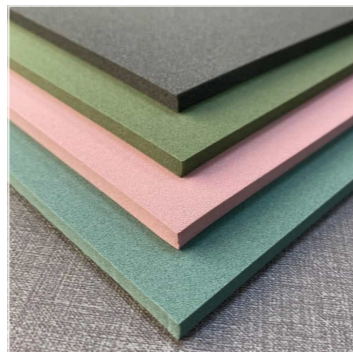

TPE foam sheets in different colors



TPE yoga mat with suede fabric surface layer



Foldable natural rubber yoga mat



Natural rubber mat with cork fabric surface layer

Aluminium Carabiners



Carabiner Aluminium Carabiner



Carabiner Aluminium Carabiner



Carabiner Aluminium Carabiner



Carabiner Aluminium Carabiner



Carabiner Wire Gate Carabiner



Carabiner One Hand Swivel Hook



Carabiner One Hand Swivel Hook



Carabiner Dog Leash Hook



Carabiner Dog Leash Hook

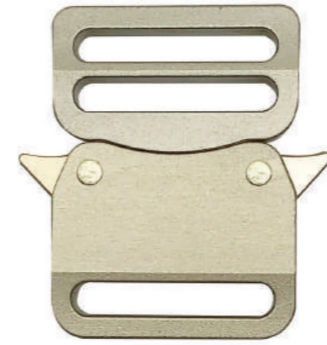

Carabiner Accessories



Carabiner Accessories



Carabiner Accessories



Carabiner Accessories



Carabiner Accessories



Carabiner Accessories



Carabiner Accessories



Carabiner Accessories



Carabiner Accessories

Carabiners Accessories

Disposable Glove

PE/EVA Foam Insert Tray



PE TPE Glove



PE TPE Glove



PE TPE Glove

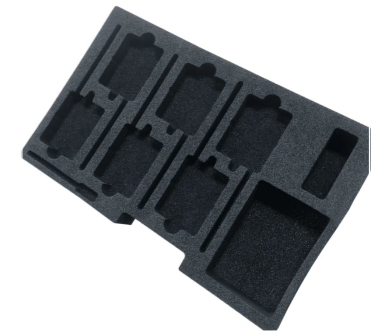
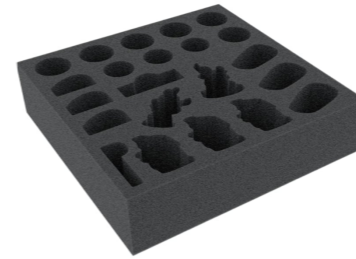

PE TPE Glove



PE TPE Glove



Nitrile Glove

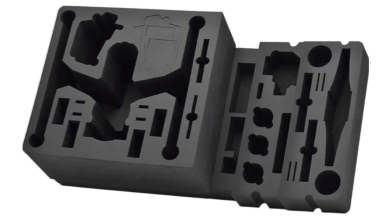
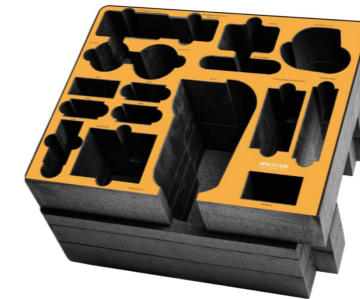

Nitrile Glove



Nitrile Glove



Disposable Glove

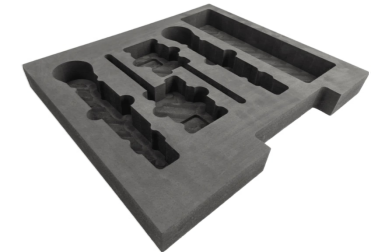

VOOF PU Sheet

VOOF PU Application



Blue



Black



Blue



Lining of backpack



Lining of helmet protective gear

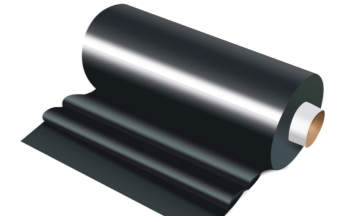

VOOF PU in rolls



Orange



Yellow



High-performance insoles

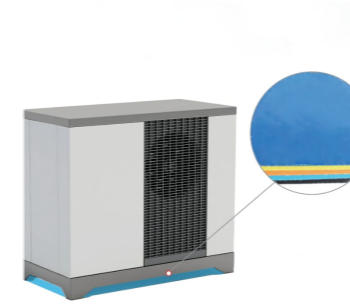

Shockproof pads for industrial equipment



Lining of luggage

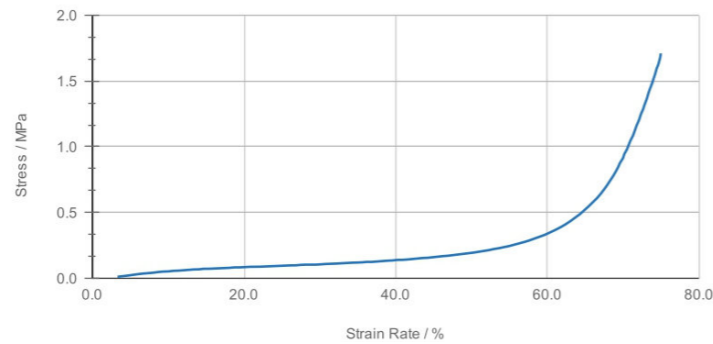

Stress Strain Curve



Industrial Vibration Reduction

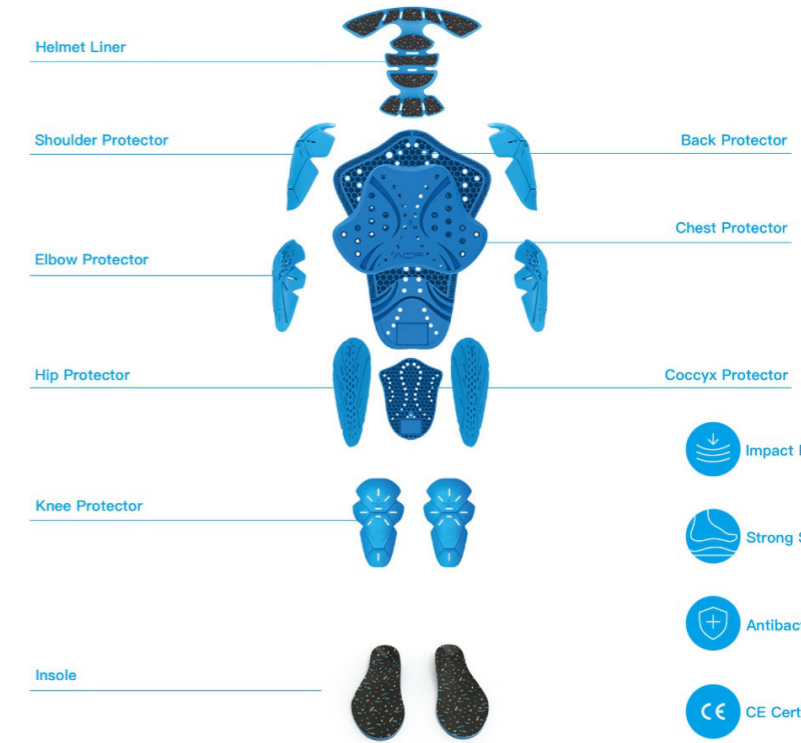

Body Protection

- Impact Res
- Strong Sup
- Antibacteri
- CE Certific

Foam/Massage Roller

Yoga/Foam Block



PE/EVA Foam Roller



PE/EVA Foam Roller

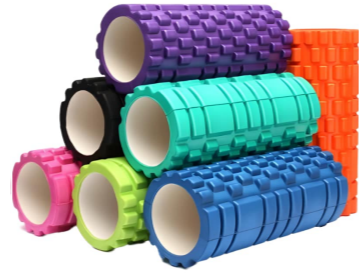

PE/EVA Foam Roller

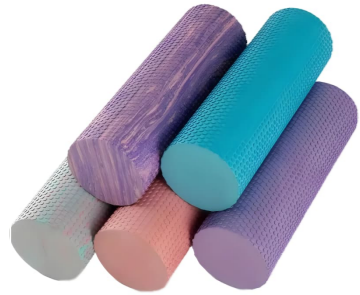

PE/EVA Foam Roller



PE/EVA Foam Roller



PE/EVA Foam Roller



PE/EVA Foam Roller



PE/EVA Foam Roller



EPP Roller

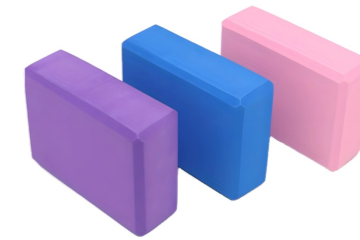

Aluminium Alloy Truss

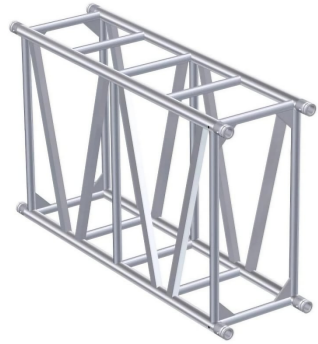

Spigot Truss



Spigot Truss



Triangle Truss



6 Way Corner



Square Al Plate Base

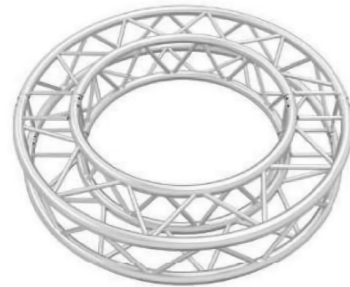

Round Truss

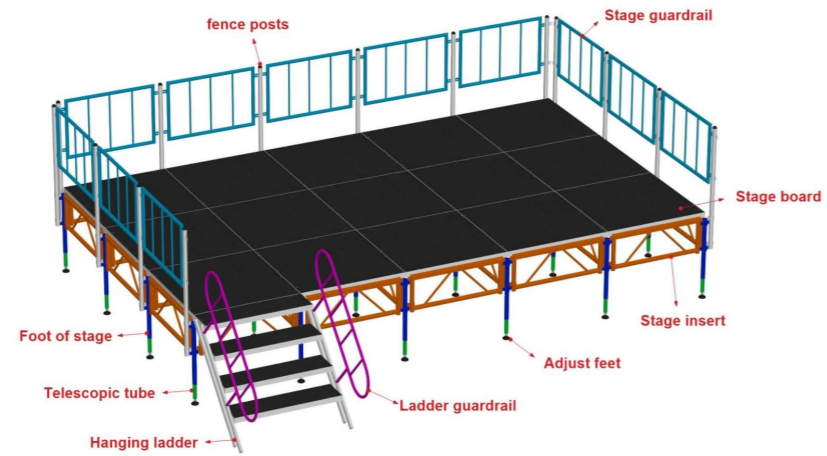

Aluminium Alloy Stage Stand



I-Beam Truss



Portal Scaffolding



Bolt



Coupler Pin Clip

Aluminium Accessories

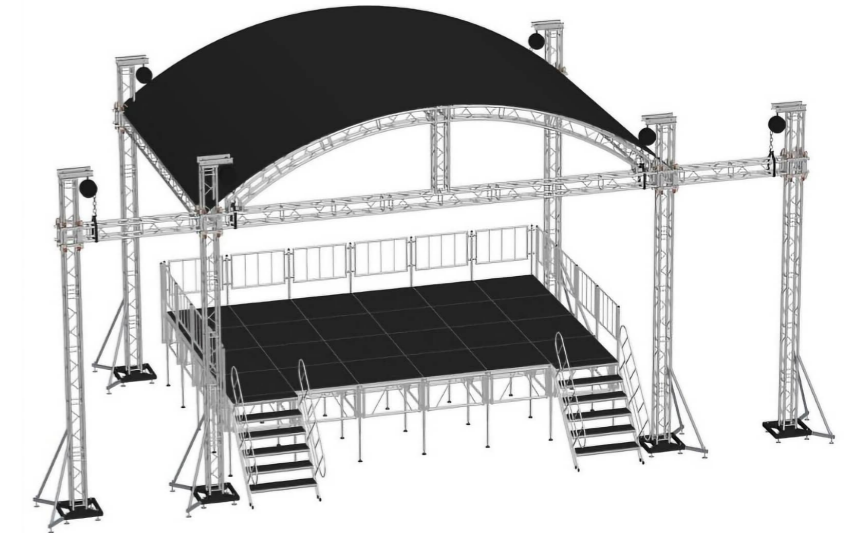

Light Truss and Stage

PRODUCT CATALOG NOTICE

Please note that this catalog presents only a selection of our product categories, along with limited product images and model references. Should any particular category pique your interest, we warmly invite you to contact us for the corresponding comprehensive catalog—where you'll find detailed specifications, expanded options, and tailored solutions to meet your exact requirements.

Send email to
sales@welle-trade.com

Or visit our website
www.welle-trade.com

Your inquiry will receive our immediate attention, as we are committed to providing complete and precise product information to facilitate your decision-making.

We look forward to the opportunity to serve you.

